

Common Mode Choke  
General differential signal line

**CMC F-Series**

## CMC3225F type

---

CMC3225F [1210 inch]

## ◆ SHAPE & DIMENSIONS

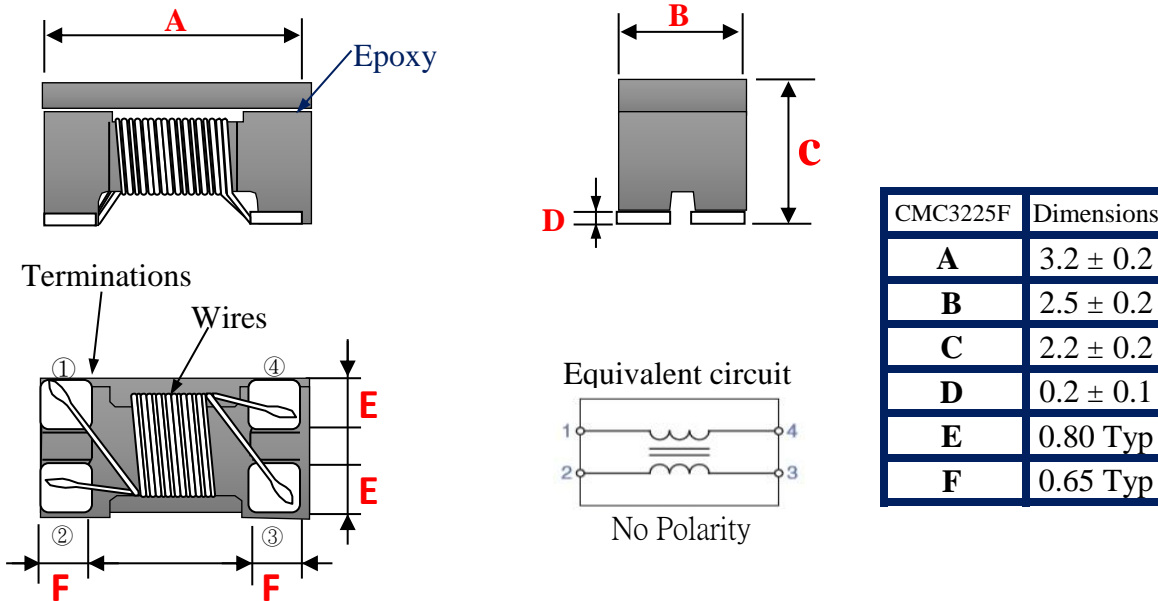

## ◆ PART NUMBER CONSTRUCTION

CMC	3225	F	-	601	-	2P	-	T
Series name	L*W*T Dimensions (mm)	F type Cut-Off Frequency		Impedance (Ω)at100MHz		Number Of Line		Taping
Common Mode Choke For Power Line	3.2*2.5*2.2	1GHz		900		2P 2lines		
				601				
				102				

## ◆ OPERATING TEMPERATURE RANGE, PACKAGE QUANTITY.

Type	Temperature range		Reel Dimensions (mm)	Package quantity (pieces/reel)
	Operating Temperature ℃	Storage Temperature ℃		
CMC3225F-Series	-40 to +85	-40 to +85	ø180	2,000

## ◆ ELECTRICAL CHARACTERISTICS

Impedance 100MHz ( $\Omega$ )	DC Resistance ( $\Omega$ ) max.	Rated Voltage (V) max.	Insulation Resistance (M $\Omega$ )min.	Rated Current (A)max.	Part No.
90 $\pm$ 25%	0.05	50	10	1500	CMC3225F-900
600 $\pm$ 25%	0.20	50	10	1000	CMC3225F-601
1000 $\pm$ 25%	0.30	50	10	1500	CMC3225F-102

## ◆ Measurement Equipment

Measurement Item	Meter	Manufacturer
Common Mode Impedance	E4991A / 4287A	Agilent
DC Resistance	16502	Chroma
Insulation Resistance	4339B / 19073	Agilent / Chroma

## ◆ PERFORMANCE CURVES

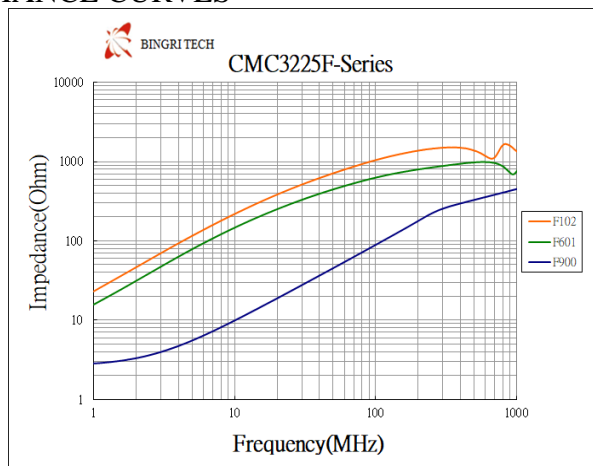

## ◆ Recommended Soldering Conditions (Please use this product by reflow soldering)

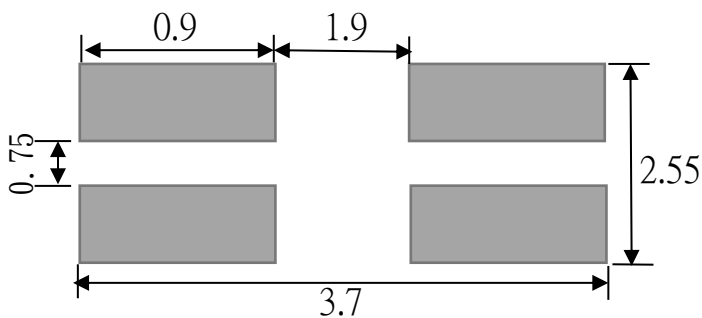

# RELIABILITY



## ◆ RECOMMENDED REFLOW PROFILE

2017/11/1

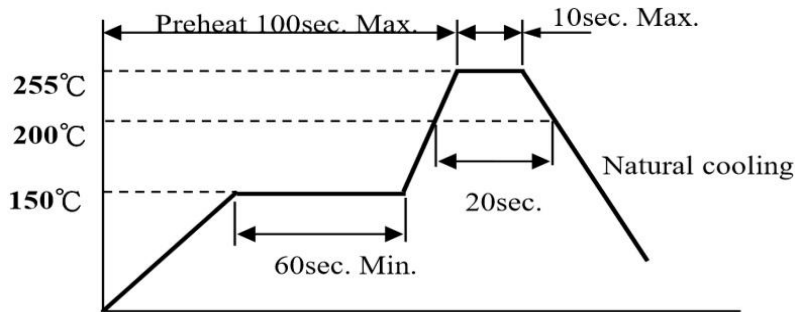

## ◆ MECHANICAL RELIABILITY

TEST ITEM	Specification & Requirement	Method Used
Solderability	The surface of terminal/pin tested shall be covered with new solder by 90%	Solder heat proof: Preheating: 150 ± 10°C 60 seconds Soldering: 245 ± 5°C for 4 ± 1 sec
Solder Heat Resistance	Components should have not evidence of Impedance: within ± 15% of initial value	Preheating: 150°C 60secs Flux: rosin Dip time: 10 ± 0.5 secs
Terminal strength	Series No.	F (Kg)
	CMC2012F/H/S	0.5
	CMC/P3216F	1.0
	CMC/P3225F	1.0
	CMC/P4532F	1.2
<b>ENDURANCE RELIABILITY</b>		
Thermal Shock	Impedance change within ± 15% Without mechanical damage	-65°C, (30 mins) -> room temp. (2 mins) 125°C, (30 mins) -> room temp. (2 mins) 50 cycles
Humidity Resistance		Apply IDC current @ 60°C ambient Humidity: 90% Duration: 168 hrs
Low Temp. Storing		Storing Temp. -40 ± 2 °C for total 168 +5/-0 hours
High Temp. Storing		Storing Temp. 125 ± 2 °C for total 168 +5/-0 hours

## ◆ Reel Dimension & Tape Dimension

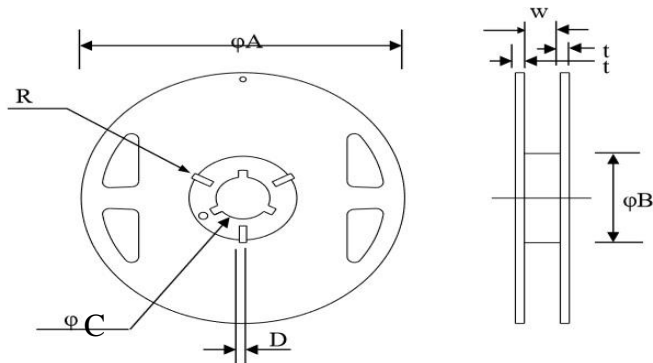

Type	A(mm)	B(mm)	C(mm)	W(mm)
7"x8mm	178±1	60±0.5	13.5±0.5	9.5±0.5
7"x12mm	178±1	60±1	13.3±0.5	13.7±0.5

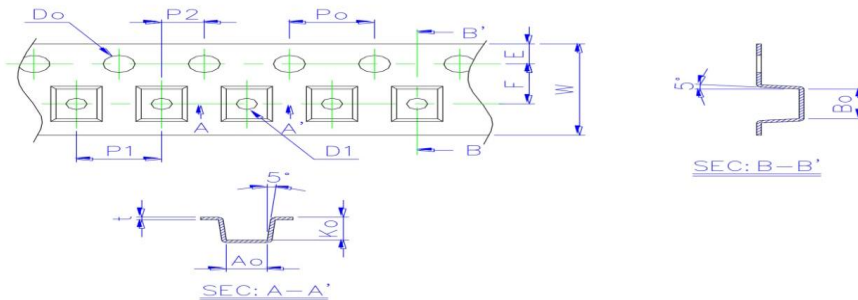

Size	Ao(mm)	Bo(mm)	Ko(mm)	W(mm)	E(mm)	F(mm)	Po(mm)	P1(mm)	Do(mm)
2012	1.50±0.05	2.35±0.05	1.45±0.05	8.00±0.20	1.75±0.10	3.50±0.05	4.00±0.05	4.00±0.10	1.50+0.10/-0.00
3216	1.88±0.05	3.50±0.05	2.10±0.05	8.00±0.20	1.75±0.10	3.50±0.05	4.00±0.05	4.00±0.10	1.50+0.10/-0.00
3225	2.88±0.10	3.65±0.10	2.50±0.10	8.00±0.10	1.75±0.10	3.50±0.05	4.00±0.10	4.00±0.10	1.50+0.10/-0.00
4532	3.45±0.10	4.90±0.10	3.05±0.10	12.00±0.20	1.75±0.10	3.50±0.05	4.00±0.05	8.00±0.10	1.50+0.10/-0.00

## ◆ Cover Tape Peel Strength

The force for tearing off cover tape is 0.05~0.69(N) in the arrow direction at the following conditions:

Temperature : 5 ~ 35°C

Humidity : 45 ~ 85%

Atmospheric pressure : 860 ~ 1060 hpa

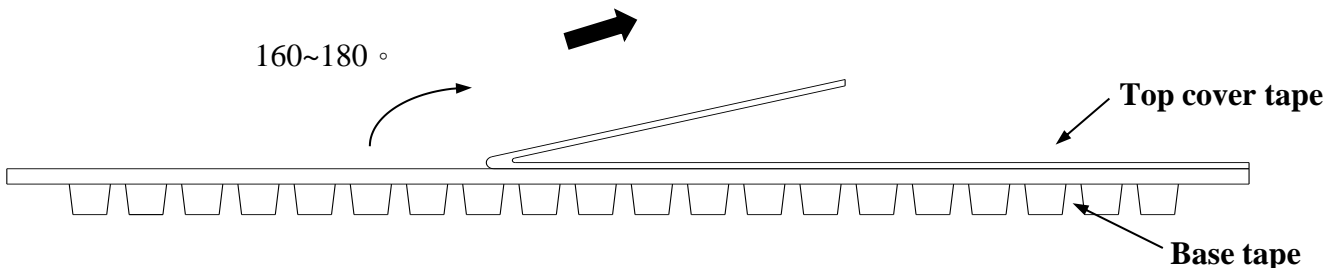

## ◆ Packaging Quantity

Chip Size	2012	3216	3225	4532
8mm / Reel	2000	2000	1000	500